

Operating Instructions Digital Audio Player

Model No. **SV-MP100V**
SV-MP110V
SV-MP120V

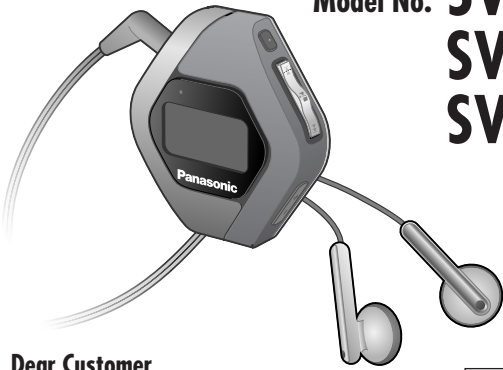

Dear Customer

Thank you for purchasing this product. Before connecting, operating or adjusting this product, please read the instructions completely. Please keep this manual for future reference.

Caution

This unit is not waterproof and should not be exposed to excessive moisture.

Panasonic Consumer Electronics Company,
Division of Panasonic Corporation of North America
One Panasonic Way Secaucus, New Jersey 07094
<http://www.panasonic.com>

Panasonic Puerto Rico, Inc.

Ave. 65 de Infantería, Km. 9.5 San Gabriel Industrial Park, Carolina, Puerto Rico 00985

Panasonic Canada Inc.

5770 Ambler Drive, Mississauga, Ontario L4W 2T3
www.panasonic.ca

© 2005 Matsushita Electric Industrial Co., Ltd.



RQTT0668-P
M0105SF0
Printed in Taiwan

- Windows Media Player (Version 9.0) Free download from <http://www.microsoft.com/downloads/>
- Supports playback of MP3 and WMA (DRM) music files
- Built-in microphone for voice recording
- Built-in FM tuner with recording function
- Portable data storage device (Plugs in directly to your PC)
- Language learning with repetition and comparison.
- Total play list (MUSIC, FM RADIO, IC RECORDER) can contain up to 383 tracks.

These tables show the mode menu items available in the MUSIC, LEARN, FM RADIO, IC RECORDER and SYSTEM modes.

MUSIC

Mode	Options
SOUND	NORMAL/ ROCK/ JAZZ/ POP/ CLASSIC/ USER DEFINE
	NORMAL/ ALL-REP/ ONE-REP/ RANDOM
	Information (Artist/ File format/ Bit Rate)
ERASE	SINGLE TRACK/ PLAYLIST/ ALL ERASE

IC RECORDER

Mode	Options
RECORD	HQ/ SP/ LP
SPEED	LOW-NOR
ERASE	SINGLE TRACK/ ALL VOICE

FM RADIO

Mode	Options
AUTO PRESET	Freq. set/ Channel set
BAND STEP	50 kHz/ 100 kHz/ 200 kHz
RECEPTION	NORMAL/ CITY

LEARN

Mode	Options
PLAY	NORMAL/ ALL-REP/ ONE-REP
REPEAT SET	TIME/ TRACE/ T.TIME
SPEED	LOW-NOR
ERASE	SINGLE TRACK/ PLAYLIST/ ALL ERASE

SYSTEM

Mode
LANGUAGE/ AUTO OFF/ BACKLIGHT/ CONTRAST/ SOUND GRAPHIC/ SLEEP TIME

Supplied accessories

- Pair of stereo earphones (LOBAB0000193)—1pc

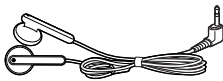

- USB Cable (K1HA05AD0004)—1pc

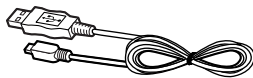

- CD-ROM (USB Driver)—1pc

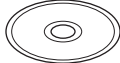

- Neck lanyard (VFC4028)—1pc

Caution: Take care when using the neck lanyard. If used improperly, it can be a choking hazard.

Use numbers indicated in parentheses when asking for replacement parts.
In U.S.A. to order accessories, refer to "Accessory Purchases" on page 4.

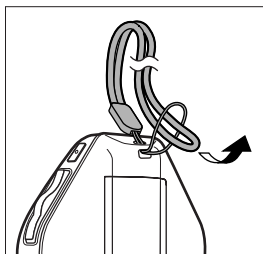

As of January 2005

Battery (not included)

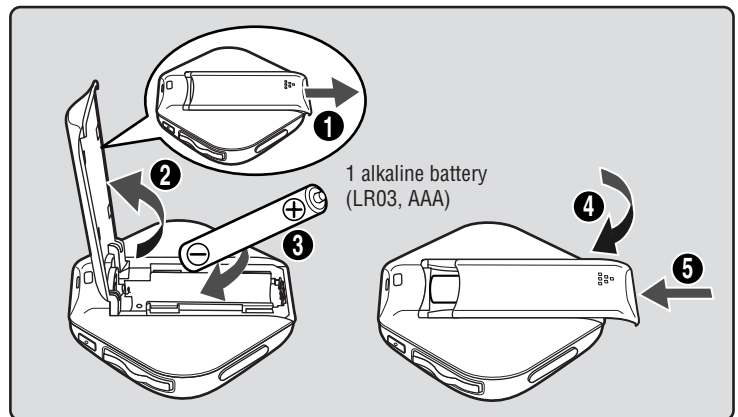

Battery indicator



Full

Empty

Replace with a fresh battery

If rechargeable batteries are to be used, rechargeable batteries manufactured by Panasonic are recommended.

User memo :

DATE OF PURCHASE _____
DEALER NAME _____
DEALER ADDRESS _____
TELEPHONE NUMBER _____

The model number and serial number of this product can be found on either the back or the bottom of the unit.

Please note them in the space provided below and keep for future reference.

MODEL NUMBER _____
SERIAL NUMBER _____

Files and Folders Structure display on your computer

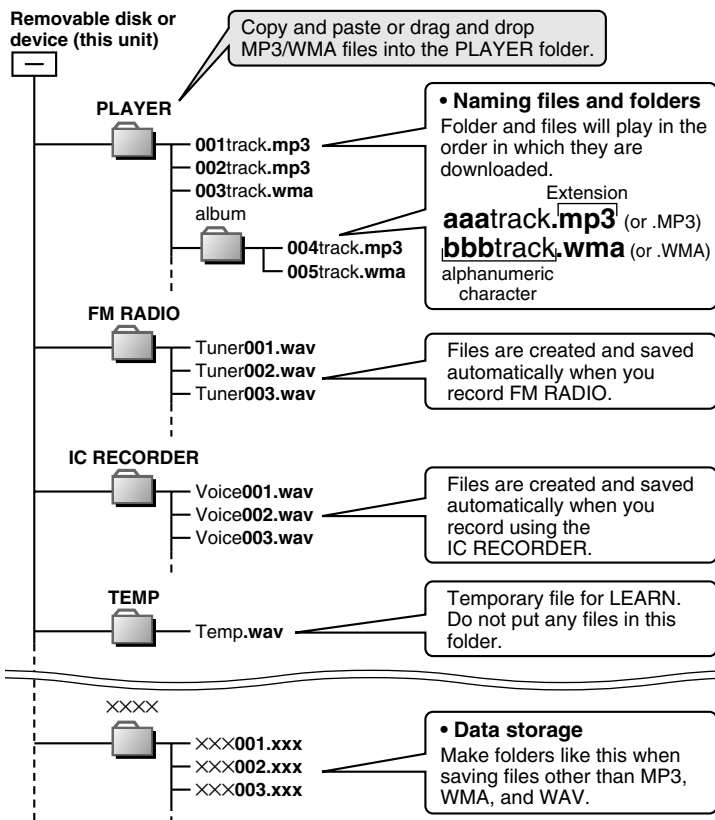

- Note**
- Total maximum 383 tracks. Total maximum 20 folders.
 - MP3 / WMA Files put into folders other than the PLAYER folder are erased when you disconnect the USB cable.
 - You cannot upload MP3/WMA files from this unit's PLAYER folder to a computer, but you can erase them.
 - Do not remove the battery while recording with the IC RECORDER or FM RADIO as all the data you were recording at the time will be lost.
 - Using the IC RECORDER as an example, assume the number of recordings has been made up to Voice100. If you delete Voice005 and Voice016, both of these become blank numbers. If you then add a recording it will become Voice005 and the next recording will become Voice016.
 - This unit is compatible with Windows Media Audio 9 (WMA9), however not with WMA9 Professional/Lossless/Voice and MBR※.
 - ※ Multiple Bit Rate: A file that contains the same content encoded at several different bit rates.
 - If you use VBR format MP3 files, some of the unit's functions can not be operated normally.

Saving Data

- The data recorded using this unit's IC RECORDER or FM RADIO can be uploaded to a PC.
- MP3 and WMA files in this unit can't be uploaded to a PC.
- You can use this unit as a removable disk for saving PC data by connecting the USB cable to a PC. (→page 5)

Displays

NO TRACK PLAY	• There is no audio data in the player.
LOW BATTERY	• The battery is dead. Change the battery.
HOLD	• The HOLD switch is on.
FULL MEMORY	• Memory is full.
TRACK OVER	• You have tried to record more than 383 tracks into a play list.

Specifications

Memory size:	SV-MP100V: 128 MB SV-MP110V: 256 MB SV-MP120V: 512 MB
Supported sampling frequency:	MP3 32 kHz, 44.1 kHz, and 48 kHz WMA 8 kHz to 44.1 kHz
Supported bit-rates:	MP3 8 kbps to 320 kbps (128 kbps is recommend) WMA 32 kbps to 192 kbps (96 kbps is recommend)
No. of channels:	Stereo, 2 channels (MUSIC, FM RADIO) Mono, 1 channel (IC RECORDER)
Frequency response:	20 Hz to 20,000 Hz (+0 dB, -6 dB) (MUSIC) 300 Hz to 4,300 Hz (IC RECORDER, HQ mode)
Mic S/N:	30 dB (IC RECORDER, HQ mode)
Radio Frequency range (FM):	87.90 MHz to 107.90 MHz (200 kHz steps) 87.50 MHz to 108.00 MHz (50/100 kHz steps)
Output:	4.5 mW + 4.5 mW (16 Ω, M3 jack)
Power supply:	DC 1.5 V (one alkaline battery)
Approximate play times:	13 hours (MUSIC) 7 hours (FM RADIO)
Approximate recording times:	13 hours (IC RECORDER, HQ mode) 7 hours (FM RADIO)
Cabinet dimensions (W×H×D):	53.2 × 61.1 × 17.5 mm (2 ¹ / ₈ " × 2 ³ / ₈ " × 1 ¹ / ₁₆ ")
Mass:	41.7 g (1.47 oz.) with battery 30.4 g (1.07 oz.) without battery

- Specifications are subject to change without notice.
- The play time shown depends on operating conditions.
- Mass and dimensions are approximate.
- MB means one million bytes. Useable capacity will be less.
- This product is compatible with Unicode. The display may not appear correctly with other character codes.

Troubleshooting guide

Before requesting service, make the following checks. If you are in doubt about any of the check points, or if the solutions indicated in the chart do not solve the problem, **refer to the "Customer Services Directory" on page 4 if you reside in the U.S.A., or refer to the "Product information" on page 3 if you reside in Canada.**

No operation	<ul style="list-style-type: none"> • The HOLD function is on. • Replace the battery if it is dead.
No sound or there is a lot of noise	<ul style="list-style-type: none"> • Ensure the earphone plug is inserted firmly. • Wipe the plug clean with a clean cloth. • Turn up the volume. • Keep this unit away from mobile telephones.
Play doesn't resume from the track where I stopped play	<ul style="list-style-type: none"> • This doesn't work if: You download, record, delete files, or change the battery. The random play mode is on.
Play doesn't start from the first track	<ul style="list-style-type: none"> • The random play mode may be on. • Play usually resumes from the track where you last stopped play. Use skip to return to the first track.
The unit stops working	<ul style="list-style-type: none"> • Take the battery out for about 5 seconds, then reinsert it. • RESET procedure <ol style="list-style-type: none"> 1. Slide the HOLD switch to ON. 2. Turn the unit on. 3. Press 3 times. 4. Press . <p>All the memories in the unit are deleted.</p>
The display is too dark or too light	<ul style="list-style-type: none"> • Adjust the contrast. (→page 8)
Play doesn't start immediately	<ul style="list-style-type: none"> • Depending on the amount of data in the unit, it may take some time for play to start after downloading / recording or changing the battery.

Maintenance

Clean with a soft, dry cloth.

Do not use any type of abrasive pad, scouring powder or solvent such as alcohol or benzine.

Care and use

• Leave some slack in the cord of the earphones and the neck lanyard if you wind them around the unit.

Do not;

- disassemble, remodel, drop, or allow the unit to get wet.
- use or store in locations directly exposed to sunlight, corrosive gases, a heat vent, or a heating appliance.
- use or store in humid or dusty locations.
- use force to open the battery lid.
- play your headphones or earphones at a high volume.

■ Batteries

- Do not peel off the covering on batteries and do not use if the covering has been peeled off.
- Align the poles + and - correctly when inserting batteries.
- Remove batteries if you do not intend to use the unit for a long time.
- Do not throw into fire, short-circuit, disassemble, or subject to excessive heat.
- Keep out of the reach of small children.
Accidental swallowing of batteries can result in stomach and intestinal damage.

■ Allergies

Discontinue use if you experience discomfort with the earphones or any other parts that directly contact your skin. Continued use may cause rashes or other allergic reactions.

■ Listening caution



Do not play your headphones or earphones at a high volume. Hearing experts advise against continuous extended play.

If you experience a ringing in your ears, reduce volume or discontinue use.

Do not use while operating a motorized vehicle. It may create a traffic hazard and is illegal in many areas.

You should use extreme caution or temporarily discontinue use in potentially hazardous situations.

Even if your headphones or earphones are the open-air type designed to let you hear outside sounds don't turn up the volume so high that you can't hear what's around you.

Sound can be deceiving. Over time your hearing "comfort level" adapts to higher volumes of sound. So what sounds "normal" can actually be loud and harmful to your hearing.

Guard against this by setting your equipment at a safe level BEFORE your hearing adapts.

To establish a safe level:

- Start your volume control at a low setting.
- Slowly increase the sound until you can hear it comfortably and clearly, and without distortion.

Once you have established a comfortable sound level:

- Leave it there.

• Microsoft, the Microsoft logo, the Windows, Windows logo, Windows NT and Windows Media are either trademarks or registered trademarks of Microsoft Corporation in the United States and other countries.



- WMA is a compression format developed by Microsoft Corporation. It achieves the same sound quality as MP3 with a file size that is smaller than that of MP3.
- MPEG Layer-3 audio decoding technology licensed from Fraunhofer IIS and Thomson multimedia.
- Other names of systems and products mentioned in these instructions are usually the registered trademarks or trademarks of the manufacturers who developed the system or product concerned.
The [™] and [®] marks are not used to identify registered trademarks and trademarks in these instructions.

Product service

1. Damage requiring service

The unit should be serviced by qualified service personnel if:

- (a) Objects or liquids have gotten into the unit; or
- (b) The unit has been exposed to rain; or
- (c) The unit does not operate normally or exhibits a marked change in performance; or
- (d) The unit has been dropped or the cabinet damaged.

2. Servicing

Do not attempt to service the unit beyond that described in these operating instructions. Refer all other servicing to authorized servicing personnel.

3. Replacement parts

When parts need replacing ensure the servicer uses parts specified by the manufacturer or parts that have the same characteristics as the original parts.

Unauthorized substitutes may result in fire, electric shock, or other hazards.

4. Safety check

After repairs or service, ask the servicer to perform safety checks to confirm that the unit is in proper working condition.

■ Product information

For product information or assistance with product operation:

In the U.S.A., refer to "Customer Services Directory" on page 4.

In Canada, contact Panasonic Canada Inc. Customer Care Centre at 905-624-5505, or visit the website (www.panasonic.ca), or an authorized Servicentre closest to you.

WARNING:

TO REDUCE THE RISK OF FIRE, ELECTRIC SHOCK OR PRODUCT DAMAGE, DO NOT EXPOSE THIS APPARATUS TO RAIN, MOISTURE, DRIPPING OR SPLASHING AND THAT NO OBJECTS FILLED WITH LIQUIDS, SUCH AS VASES, SHALL BE PLACED ON THE APPARATUS.

THE FOLLOWING APPLIES ONLY IN THE U.S.A.:

CAUTION:

This equipment has been tested and found to comply with the limits for a Class B digital device, pursuant to Part 15 of the FCC Rules.

These limits are designed to provide reasonable protection against harmful interference in a residential installation. This equipment generates, uses and can radiate radio frequency energy and, if not installed and used in accordance with the instructions, may cause harmful interference to radio communications. However, there is no guarantee that interference will not occur in a particular installation. If this equipment does cause harmful interference to radio or television reception, which can be determined by turning the equipment off and on, the user is encouraged to try to correct the interference by one or more of the following measures:

- Reorient or relocate the receiving antenna.
- Increase the separation between the equipment and receiver.
- Connect the equipment into an outlet on a circuit different from that to which the receiver is connected.
- Consult the dealer or an experienced radio/TV technician for help.

Any unauthorized changes or modifications to this equipment would void the user's authority to operate this device.

This device complies with Part 15 of the FCC Rules. Operation is subject to the following two conditions: (1) This device may not cause harmful interference, and (2) this device must accept any interference received, including interference that may cause undesired operation.

Responsible Party: Panasonic Corporation of North America
One Panasonic Way Secaucus, NJ, 07094 USA
Telephone No.: 1-800-211-7262

THE FOLLOWING APPLIES ONLY IN CANADA:

This Class B digital apparatus complies with Canadian ICES-003.

Caution:

- Use only the provided shielded interface cables when connecting to computer.
- To reduce risk of radio interference caused by headphone, earphone or microphone cable, only purchase accessories with cable length less than 3 m.

Limited Warranty (ONLY FOR U.S.A.)

Panasonic Consumer Electronics Company,
Division of Panasonic Corporation of North America
One Panasonic Way Secaucus, New Jersey 07094

Panasonic Puerto Rico, Inc.
Ave. 65 de Infantería, Km. 9.5
San Gabriel Industrial Park, Carolina, Puerto Rico 00985

Panasonic Portable Audio Products Limited Warranty

Limited Warranty Coverage

If your product does not work properly because of a defect in materials or workmanship, Panasonic Consumer Electronics Company or Panasonic Puerto Rico, Inc. (collectively referred to as "the warrantor") will, for the length of the period indicated on the chart below, which starts with the date of original purchase ("warranty period"), at its option either (a) repair your product with new or refurbished parts, or (b) replace it with a new or a refurbished product. The decision to repair or replace will be made by the warrantor.

Product or Part Name	Parts	Labor
All Portable Audio Products except item listed below	One (1) Year	One (1) Year
Rechargeable batteries (in exchange for defective item)	Ten (10) Days	Not applicable

During the "Labor" warranty period there will be no charge for labor. During the "Parts" warranty period, there will be no charge for parts. You must mail-in your product during the warranty period. This Limited Warranty excludes both parts and labor for batteries, antennas, and cosmetic parts (cabinet). This warranty only applies to products purchased and serviced in the United States or Puerto Rico. This warranty is extended only to the original purchaser of a new product which was not sold "as is".

Mail-In Service

For assistance in the continental U.S.A. in obtaining repairs please ship the product to:

**Panasonic Service Company
Customer Servicer
Suite B
4900 George McVay Drive
McAllen, TX 78503**

For assistance in Puerto Rico call Panasonic Puerto Rico, Inc. (787)-750-4300 or fax (787)-768-2910.

When shipping the unit carefully pack and send it prepaid, adequately insured and preferably in the original carton. Include a letter detailing the complaint and provide a day time phone number where you can be reached.

Customer Services Directory

Obtain Product Information and Operating Assistance; locate your nearest Dealer or Servicer; purchase Parts and Accessories; or make Customer Service and Literature requests by visiting our Web Site at:

<http://www.panasonic.com/consumersupport>

or, contact us via the web at:

<http://www.panasonic.com/contactinfo>

You may also contact us directly at:

1-800-211-PANA (7262),

Monday-Friday 9 am-9 pm; Saturday-Sunday 10 am-7 pm, EST.

For hearing or speech impaired TTY users, TTY: 1-877-833-8855

IF REPAIR IS NEEDED DURING THE WARRANTY PERIOD THE PURCHASER WILL BE REQUIRED TO FURNISH A SALES RECEIPT/PROOF OF PURCHASE INDICATING DATE OF PURCHASE, AMOUNT PAID AND PLACE OF PURCHASE. CUSTOMER WILL BE CHARGE FOR THE REPAIR OF ANY UNIT RECEIVED WITHOUT SUCH PROOF OF PURCHASE.

Limited Warranty Limits And Exclusions

This warranty ONLY COVERS failures due to defects in materials or workmanship, and DOES NOT COVER normal wear and tear or cosmetic damage. The warranty ALSO DOES NOT COVER damages which occurred in shipment, or failures which are caused by products not supplied by the warrantor, or failures which result from accidents, misuse, abuse, neglect, mishandling, misapplication, alteration, faulty installation, set-up adjustments, misadjustment of consumer controls, improper maintenance, power line surge, lightning damage, modification, introduction of sand, humidity or liquids, commercial use such as hotel, office, restaurant, or other business or rental use of the product, or service by anyone other than a Factory Servicenter or other Authorized Servicer, or damage that is attributable to acts of God.

THERE ARE NO EXPRESS WARRANTIES EXCEPT AS LISTED UNDER "LIMITED WARRANTY COVERAGE". THE WARRANTOR IS NOT LIABLE FOR INCIDENTAL OR CONSEQUENTIAL DAMAGES RESULTING FROM THE USE OF THIS PRODUCT, OR ARISING OUT OF ANY BREACH OF THIS WARRANTY. (As examples, this excludes damages for lost time, travel to and from the servicer, loss of or damage to media or images, data or other memory or recorded content. The items listed are not exclusive, but are for illustration only.)

ALL EXPRESS AND IMPLIED WARRANTIES, INCLUDING THE WARRANTY OF MERCHANTABILITY, ARE LIMITED TO THE PERIOD OF THE LIMITED WARRANTY.

Some states do not allow the exclusion or limitation of incidental or consequential damages, or limitations on how long an implied warranty lasts, so the exclusions may not apply to you.

This warranty gives you specific legal rights and you may also have other rights which vary from state to state. If a problem with this product develops during or after the warranty period, you may contact your dealer or Servicer. If the problem is not handled to your satisfaction, then write to the warrantor's Consumer Affairs Department at the addresses listed for the warrantor.

PARTS AND SERVICE, WHICH ARE NOT COVERED BY THIS LIMITED WARRANTY, ARE YOUR RESPONSIBILITY.

Accessory Purchases

Purchase Parts, Accessories and Instruction Books online for all Panasonic Products by visiting our Web Site at: <http://www.pasc.panasonic.com>

or, send your request by E-mail to: npcparts@us.panasonic.com

You may also contact us directly at:

1-800-332-5368 (Phone) 1-800-237-9080 (Fax Only) (Monday - Friday 9 am to 8 pm, EST.)

Panasonic Services Company

20421 84th Avenue South, Kent, WA 98032

(We Accept Visa, MasterCard, Discover Card, American Express, and Personal Checks)

For hearing or speech impaired TTY users, TTY: 1-866-605-1277

Service in Puerto Rico

Panasonic Puerto Rico, Inc.

Ave. 65 de Infantería, Km. 9.5, San Gabriel Industrial Park, Carolina, Puerto Rico 00985
Phone (787)750-4300, Fax (787)768-2910

Limited Warranty (ONLY FOR CANADA)

Panasonic Canada Inc.

5770 Ambler Drive, Mississauga, Ontario L4W 2T3

PANASONIC/TECHNICS PRODUCT - LIMITED WARRANTY

Panasonic Canada Inc. warrants this product to be free from defects in material and workmanship and agrees to remedy any such defect, or at its option, replace the product for a period as stated below from the date of original purchase.

Technics Audio Product ————— One (1) year, parts and labour
Panasonic Audio & DVD Product ————— One (1) year, parts and labour
Accessories including rechargeable batteries ————— Ninety (90) days

LIMITATIONS AND EXCLUSIONS

This warranty does not apply to products purchased outside Canada or to any product which has been improperly installed, subjected to usage for which the product was not designed, misused or abused, damaged during shipping, or which has been altered or repaired in any way that affects the reliability or detracts from the performance, nor does it cover any product which is used commercially. Dry cell batteries are also excluded from coverage under this warranty.

This warranty is extended to the original end user purchaser only. A purchase receipt or other proof of date of original purchase is required before warranty service is performed.

THIS EXPRESS, LIMITED WARRANTY IS IN LIEU OF ALL OTHER WARRANTIES, EXPRESS OR IMPLIED, INCLUDING ANY IMPLIED WARRANTIES OF MERCHANTABILITY AND FITNESS FOR A PARTICULAR PURPOSE.

IN NO EVENT WILL PANASONIC CANADA INC. BE LIABLE FOR ANY SPECIAL, INDIRECT OR CONSEQUENTIAL DAMAGES.

In certain instances, some jurisdictions do not allow the exclusion or limitation of incidental or consequential damages, or the exclusion of implied warranties, so the above limitations and exclusions may not be applicable.

Richmond, British Columbia

Panasonic Canada Inc.
12111 Riverside Way Richmond, BC V6W 1K8
Tel: (604) 278-4211
Fax: (604) 278-5627

Calgary, Alberta

Panasonic Canada Inc.
6835-8th St. N. E. Calgary, AB T2E 7H7
Tel: (403) 295-3955
Fax: (403) 274-5493

Mississauga, Ontario

Panasonic Canada Inc.
5770 Ambler Dr. Mississauga, ON L4W 2T3
Tel: (905) 624-8447
Fax: (905) 238-2418

Lachine, Québec

Panasonic Canada Inc.
3075, rue Louis A. Amos Lachine, QC H8T 1C4
Tel: (514) 633-8684
Fax: (514) 633-8020

IF YOU SHIP THE PRODUCT TO A SERVICENTRE

Carefully pack and send prepaid, adequately insured and preferably in the original carton. Include details of the defect claimed, and proof of date of original purchase.

Location of Controls

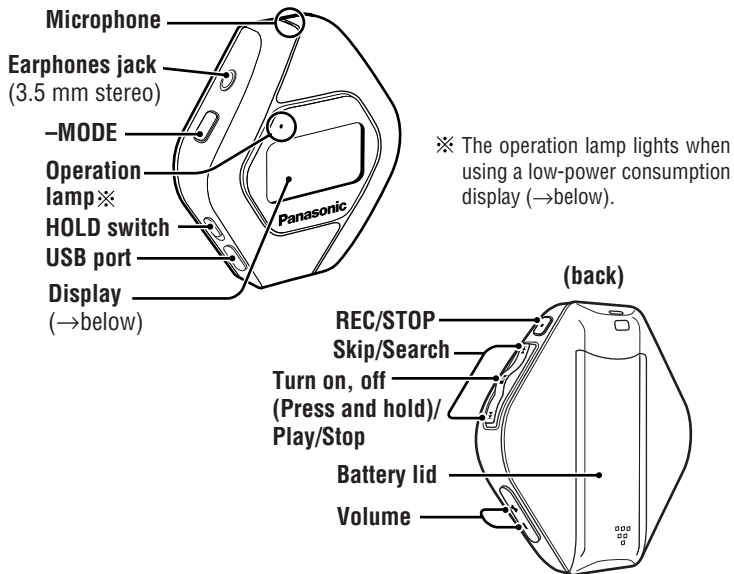

■ Display

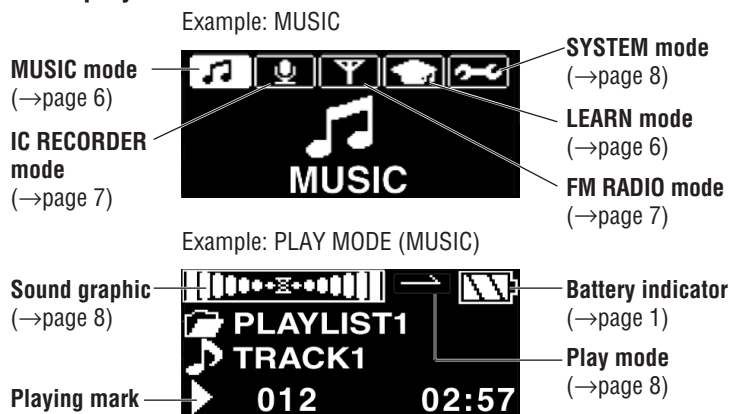

■ Low-power consumption display

- Power consumption is reduced by dimming the brightness of the display's back light. You can set the time until the display changes to a low-power consumption one. (→page 8 "SYSTEM, BACKLIGHT")
- Press any key on the unit to cancel the low-power consumption display. When the back light lights, perform the next operation.

HOLD switch

Button operations are ignored. It prevents:

- The unit turning on unexpectedly causing the battery to run down.
- Interruptions to play or recording.



(before operation)

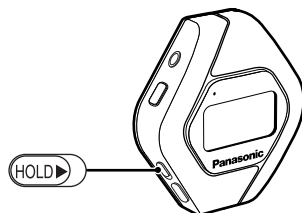

System Requirements

- OS: Microsoft® Windows® 98SE, Windows® Me, Windows® 2000 Professional, Windows® XP Home Edition/Professional
 Drive: CD-ROM Drive
- The player and USB Driver cannot be used on Microsoft® Windows® 3.1, Windows® 95, Windows® 98, Windows NT® and Macintosh®.
- USB Driver:
- Operation on an upgraded OS is not guaranteed.
 - Operation on an OS other than the one pre-installed is not guaranteed.
 - Multi-CPU or Multi-boot environments are not supported.
 - Only users having system administrator (Administrator) authority can use this software.

Connecting to a computer and downloading files

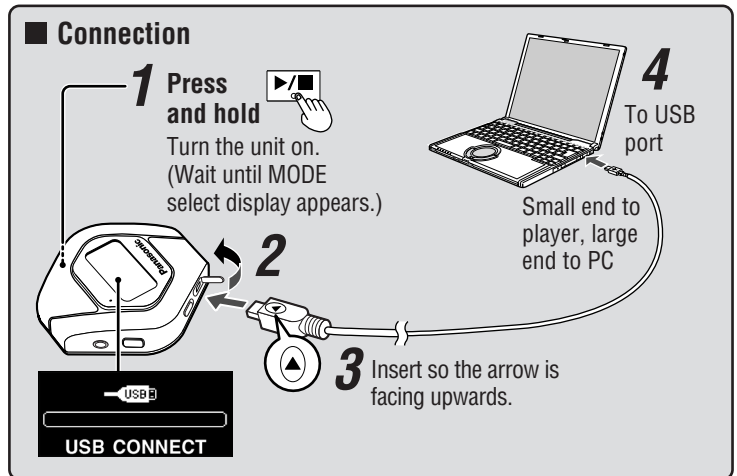

■ After connection

- **Windows® ME, 2000, or XP:** The computer automatically finds and installs the driver for the player.
 - **Windows® 98SE:** Put the included CD-ROM in your disk drive, then follow the instructions on the computer screen to install the driver.
- The player appears in My Computer or Explorer as a removable disk or device.

■ Downloading MP3 and WMA

- 1. In My Computer or Explorer, open the player's folder (removable disk or device).**
 - 2. Open the PLAYER folder.**
 - 3. Copy and paste or drag and drop the MP3/WMA files from your computer's folder into the PLAYER folder.**
 - "DOWNLOAD" appears on the player's display. When downloading is completed, "USB CONNECT" re-appears.
 - 4. Disconnect the USB cable if instructed to do so in the PC's operating instructions.**
- You can first put files into a new folder and then put that folder into the PLAYER folder. The folders are treated as sublists by the player and the names appear when you select play lists.

- Note**
- The first 20 characters of a file name you create on a computer are displayed on this unit.
 - There are some characters which cannot be displayed due to an embedded font data limitation.
 - Supports MP3 ID3 V1 tags, ID3 V2 tags and WMA tags.
 - If there are no ID3 tags, the display shows the "filename.mp3".
 - You cannot play MP3/WMA files that are in the player through the computer.
 - Ensure the USB cable is kept as straight as possible. Bending it too much may cause an accident.
 - Operation cannot be guaranteed if you use a USB hub or extension cable.
 - ID3 tags will not be displayed correctly if the language of the ID3 tag recorded for the MP3 is different from the language setting for this unit.
 - Compatible with WMA (DRM).
 - The player will turn off when downloading is completed.

Playing tracks (MUSIC mode)

Do each step within 10 seconds

Preparation: Download (→page 5) or record tracks (→page 7)

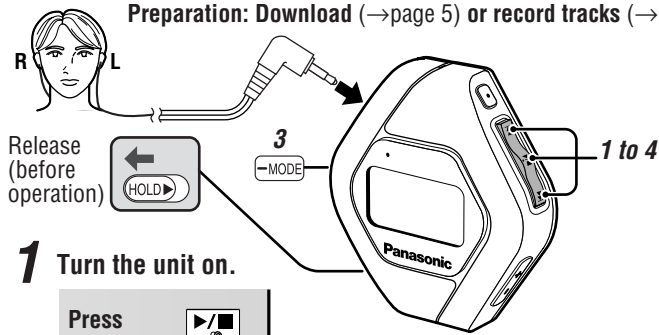

1 Turn the unit on.

Press and hold

The unit will highlight the mode last used.

2 Select MUSIC.

Skip this step if MUSIC is already selected.

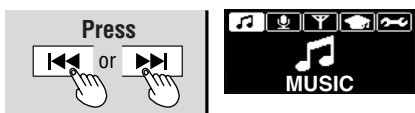

Adjust the volume	Press VOL- or VOL+ (0-25)	
Setting mode Other modes	Press and hold MODE	Skip Press backward or forward
A-B repeat Play repeats between the two points.	Press MODE at the start point (A) and once more at the end point (B) Press MODE to cancel.	Stop Press STOP Resume When you next press STOP , play resumes from where you stopped it.

3 Select the play list.

To play recordings, select an FM RADIO play list.

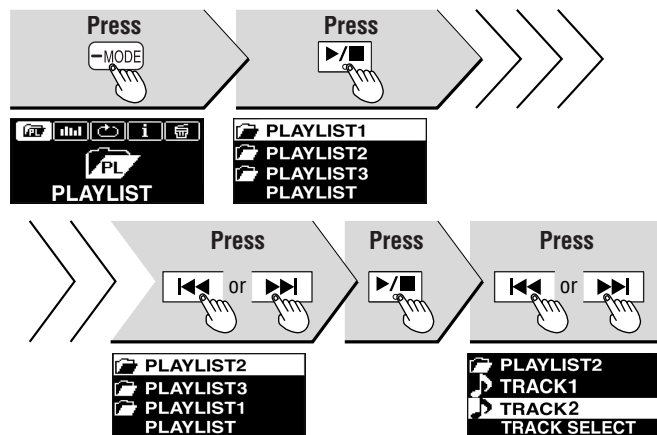

4 Start play.



Play stops at the end of the list.

Using the language learner (LEARN mode)

Do each step within 10 seconds

Preparation: Download the language learning model recording.

Select LEARN and use **Play, Skip, Search, Stop, Resume, Off** and **change modes** as you would in the MUSIC mode. (→ above)

Repeating and listening to model recordings (TRACE BACK)

Repeat and listen to the specified trace back segment.

1 Turn on the TRACE BACK function. (→ page 8, "LEARN, REPEAT SET").

2 During play, press **MODE**.

3 Listen to the model recording.

Play goes back 6 seconds and repeats 3 times. The number of times to repeat and the trace back time can be changed. (→ page 8, "LEARN, REPEAT SET")



Comparing model recordings and your voice (COMPARE)

You can continuously play and compare pronunciation of the model recording with your recorded voice.

1 Start play.

2 Press **REC/STOP**.

3 When "RECORDING" appears, speak into the microphone.

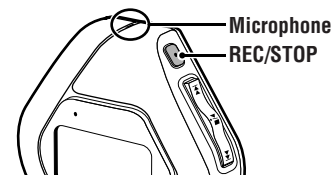
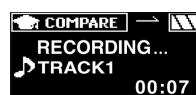

4 Press **REC/STOP**.

5 When "PLAYING" appears, listen to the model recording and your recorded voice.

Both play continuously 3 times. The number of times it is repeated can be changed. (→ page 8, "LEARN, REPEAT SET")

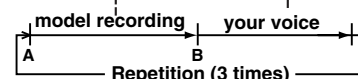

Note • During TRACE BACK and A-B repeat function, if you press **REC/STOP**, the COMPARE function will not work.

Using the FM radio (FM RADIO mode)

Do each step within 10 seconds

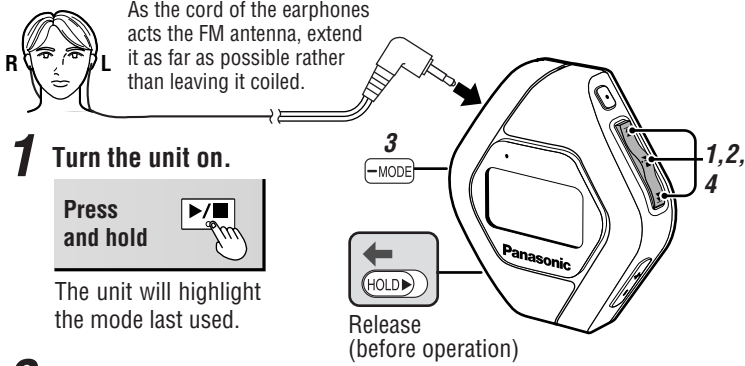

As the cord of the earphones acts the FM antenna, extend it as far as possible rather than leaving it coiled.

1 Turn the unit on.



The unit will highlight the mode last used.

2 Select FM RADIO.

Skip this step if FM RADIO is already selected.

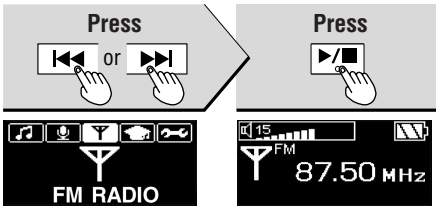

3 Select manual or preset mode.

Each time you press

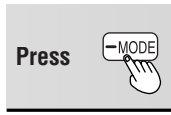

Manual (No display)

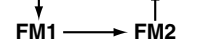

• FM1, FM2 : This needs to be preset beforehand.
(→ below "Presetting stations")

4 Select the station.

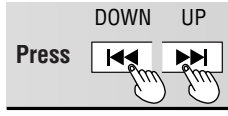

- In the manual mode, press and hold until the frequency starts scrolling to start automatic tuning. Tuning stops when a station is found.
- The tuning band steps can be changed (BAND STEP → page 8)

Adjust the volume	Press -VOL or +VOL (0-25)
Setting mode Other modes	Press and hold -MODE
Off	Press and hold ▶/■

Recording the radio

While listening to the station.



Recording time
(Available time → Right)

To play the recording
Select MUSIC mode, then select the FM RADIO play list. (→page 6)

Show available time

Press **-MODE**.
Press again to show the recording time.

Stop

Press **REC/STOP**.

Presetting stations (FM1, FM2)

FM1: 20 stations can be stored.

FM2: 10 stations can be stored.

AUTO



Select **YES**.

AUTO PRESET will start. The radio screen automatically returns when AUTO PRESET is finished.

MANUAL

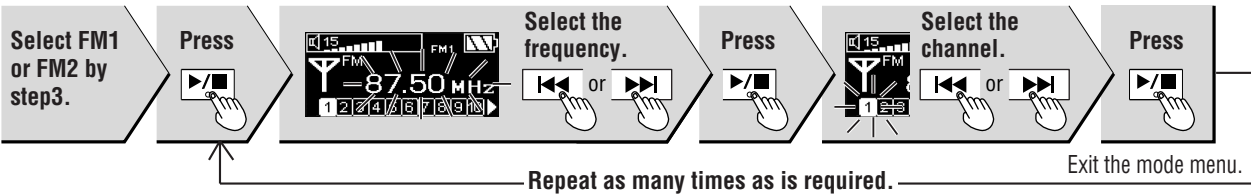

Exit the mode menu.

Voice recording (IC RECORDER mode)

Do each step within 10 seconds

1 Turn the unit on.



The unit will highlight the mode last used.

2 Select IC RECORDER.

Skip this step if IC RECORDER is already selected.

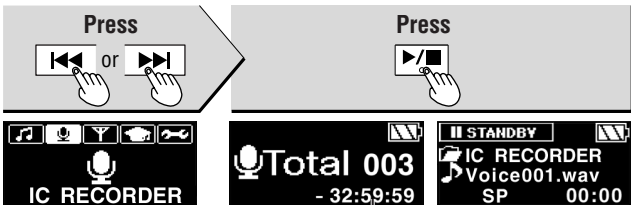

Available time

• "NO TRACK PLAY" appears on the display if there is no wave file.

3 Start recording.



Recording time
(Available time → below)

4 Speak into the microphone.

Show available time	Press -MODE . Press again to show the recording time.
Stop recording	Press REC/STOP .
To play recorded tracks	Press ▶/■ . After all recorded tracks are played the unit returns to standby. During play, press again to stop and return to standby.
Setting mode Other modes	Press and hold -MODE
Off	Press and hold ▶/■

- Skip and Search method is the same as MUSIC mode.
- The unit will turn off if left in standby mode for more than 5 minutes.

You can set various items in each mode.

1. Select MODE

2. Settings for selected mode displayed.

3. Select the desired item

4. Set

5. Confirm

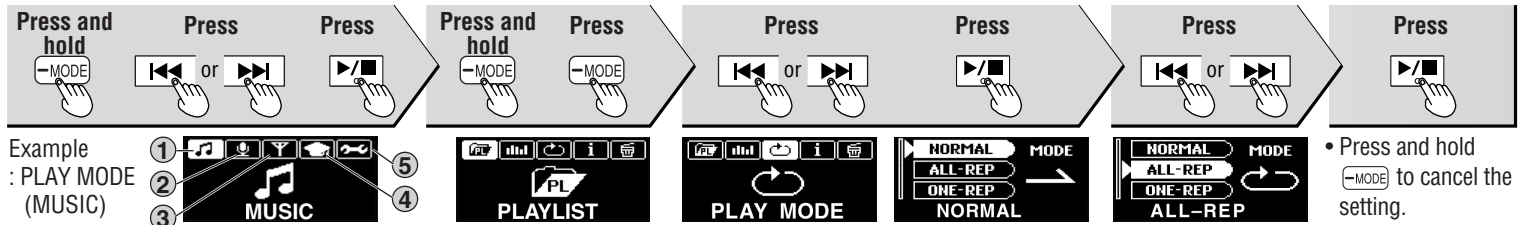

Example
: PLAY MODE (MUSIC)

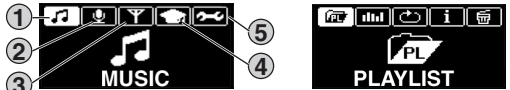

• This step is not necessary with SYSTEM.

• Press and hold **-MODE** to cancel the setting.

1 MUSIC

▶ **PLAYLIST**

(→ page 6, MUSIC mode, step 3)

▶ **SOUND MODE**



NORMAL: No change in sound
※: Switching REMASTER on/off is possible → below

ROCK: Adds impact

JAZZ: Adds club-like atmosphere

POP: Clarifies the treble range

CLASSIC: Adds concert hall-like atmosphere

USER DEFINE:
Adjust **BASS** and **TREBLE** between -12dB and +12dB

※: REMASTER (Digital Re-master)
You can regenerate signal frequency lost during compression, restoring the sound to near pre-compression form.
Press **▶/■** and then press **◀▶**, **▶▶** to set on/off.

ON: Sound enhanced

OFF: Conserves battery life

▶ **PLAY MODE**



→ **NORMAL:** Normal play
↻ **ALL-REP:** All tracks repeat in a list
1-↻ **ONE-REP:** 1 track repeat
◻ **RANDOM:** All tracks random repeat in a list.

▶ **INFO. MODE**

Show artist and data information

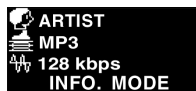

▶ **ERASE MODE**

Erasing



• When selecting ALL, press **◀▶** (YES) and press **▶/■**.

3 FM RADIO

▶ **AUTOPRESET AUTO PRESET**

(→ page 7, FM RADIO mode, Presetting stations)

▶ **BAND STEP BAND STEP**

The tuning band step



Converting the steps erases all preset stations.

▶ **RECEPTION RECEPTION**



Select CITY if reception is poor.

4 LEARN

▶ **PLAYLIST**

(→ page 6, MUSIC mode, step 3)

▶ **PLAY MODE**

(Same method as MUSIC)

※ However no RANDOM setting.

▶ **REPEAT SET**



TIME: Number of times to repeat
TRACE※: TRACE / A-B repeat
T.TIME: Number of seconds to trace

※ TRACE

Repeat and listen to the specified trace back segment.

※ A-B repeat

Play repeats between the two points.

▶ **SPEED MODE (Same method as IC RECORDER)**

▶ **ERASE MODE (Same method as MUSIC)**

2 IC RECORDER

▶ **RECORD MODE**

The record mode

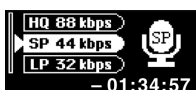

[Recording time guide (in hours)]
(Maximum hours available when player is empty of files.)

Mode	SV-MP 100V	SV-MP 110V	SV-MP 120V
HQ	3	6	12
SP	6	12	24
LP	9	18	36

▶ **SPEED MODE**

The play speed (Low-Normal)

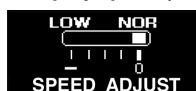

▶ **ERASE MODE (Same method as MUSIC)**

• There is no PLAYLIST.

5 SYSTEM

▶ **LANGUAGE**



▶ **AUTO OFF**

Setting the elapsed time before the power automatically turns off due to inactivity



▶ **BACKLIGHT**

Setting the duration the display will light when a button is pressed



▶ **CONTRAST**

Adjusting the screen contrast



▶ **SOUND GRAPHIC**

Selecting the display graphic mode

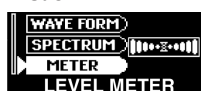

▶ **SLEEP TIME**

Setting the time the unit will automatically turn off



• The display will show “.zZ” when SLEEP is selected.